

XILIA



WALL-AROUND

ARCHITECTURAL SYSTEM



X I L I A



Soluzioni che creano ambienti
meravigliosamente connessi
Solutions for beautifully connected
environments

IT Wall-Around è la risposta concreta di Xilia alla necessità di rivestimento e personalizzazione degli spazi. Un sistema architettonico completo caratterizzato da boiserie, porte integrate, armadiature e accessori, in grado di esaltare gli spazi per funzionalità, stile e design.

Wall-Around rappresenta una soluzione architettonica innovativa pensata per connettere tra loro gli spazi, offrendo la possibilità di sviluppare un abito sartoriale che si adatta perfettamente ad ogni ambiente.

EN Wall-Around is Xilia's concrete response to the need for covering and customizing spaces. A complete architectural system characterized by boiserie, integrated doors, wardrobes and accessories, capable of enhancing the spaces for functionality, style and design.

Wall-Around represents an innovative architectural solution designed to connect spaces together, offering the possibility of developing a tailored suit that adapts perfectly to any environment.













Wall System

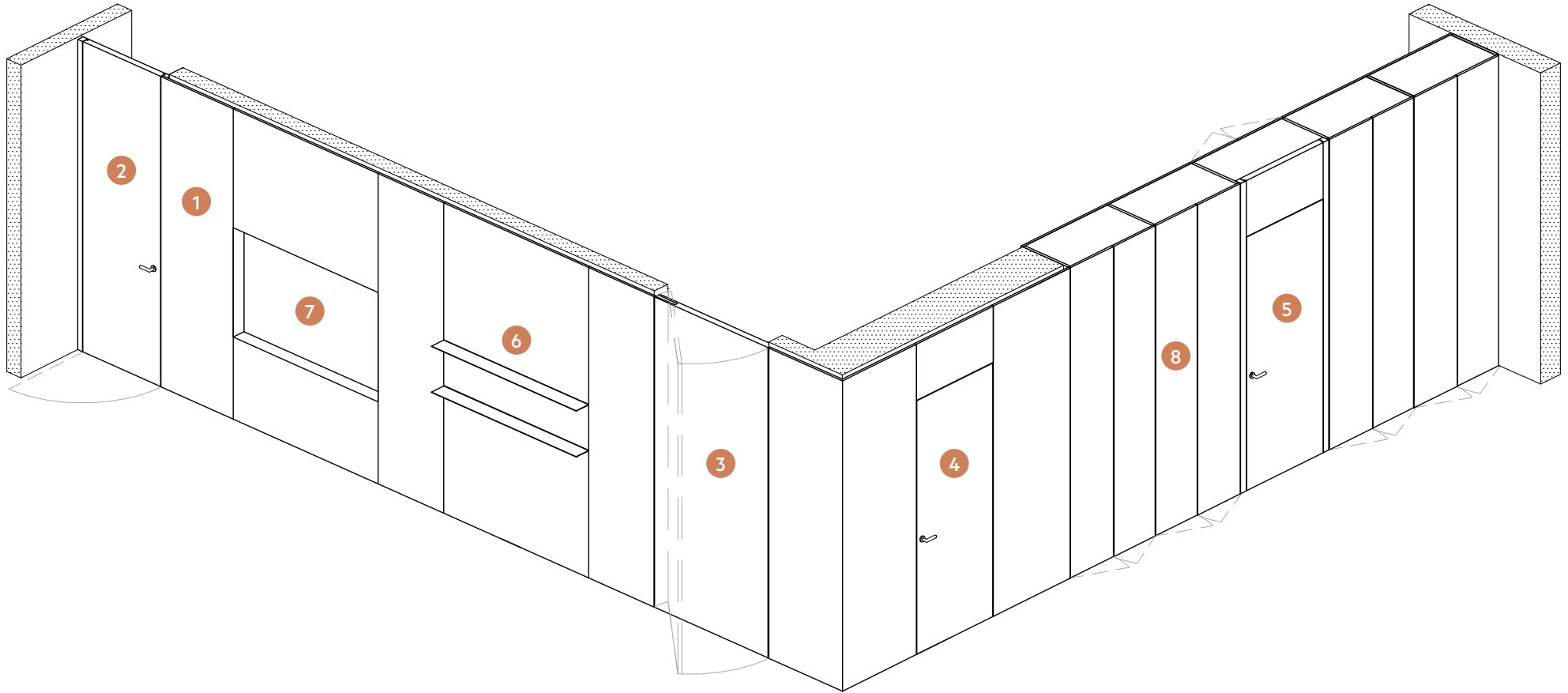

- 01 Boiserie
- 02 Porta a battente a tutta altezza
- 03 Porta Pivot
- 04 Porta a battente con sopraluce
- 05 Porta integrata con armadiature
- 06 Mensola
- 07 Case TV
- 08 Armadiature

- 01 Boiserie
- 02 Full height hinged door
- 03 Porta Pivot / Pivot door
- 04 Hinged door with transom
- 05 Wardrobe pass-through hinged door
- 06 Shelf
- 07 TV case
- 08 Wardrobes

Boiserie



IT La versatilità del sistema boiserie permette di rivestire pareti di ogni dimensione, creando composizioni sartoriali dalle infinite possibilità progettuali. Una soluzione che risponde alla necessità di risolvere le problematiche tipiche del cantiere, che presta grande attenzione alle soluzioni d'angolo e dove ogni dettaglio viene progettato per garantire la massima integrazione con dispositivi e impianti domestici.

EN The versatility of the boiserie system allows to cover walls of any size, creating tailor-made compositions with infinite design possibilities. A solution that responds to the need to solve the typical problems of the construction site, which pays great attention to corner solutions and where every detail is designed to guarantee maximum integration with all of the existing devices and systems.



Wall System: boiserie, armadi integrati, porta a tutta altezza
Wall System: boiserie, integrated wardrobes, full height hinged door
Finitura / Finish: Skin, Graphite Oak

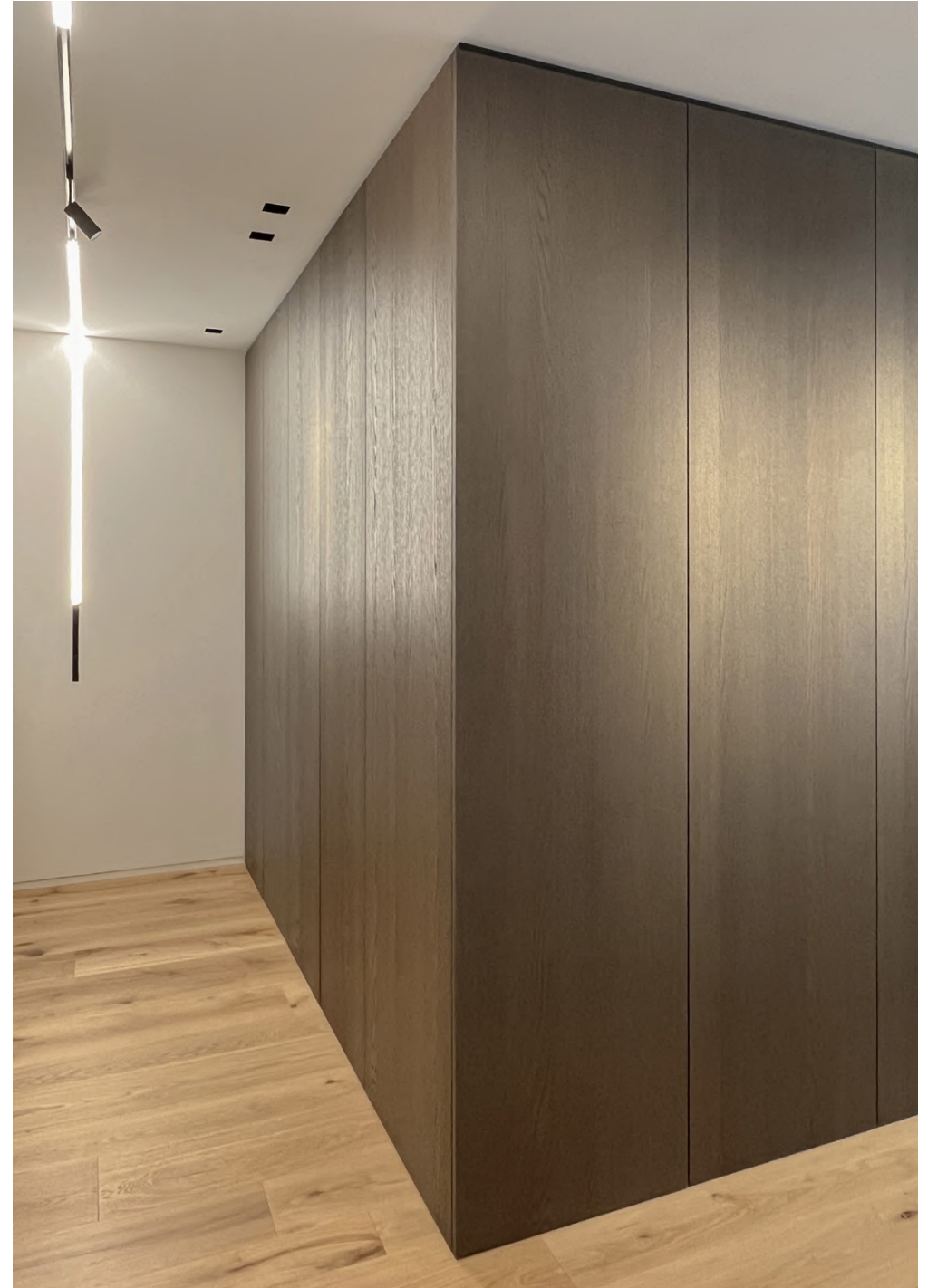

Boiserie: caratteristiche tecniche

Boiserie: technical features

Dimensioni e ancoraggio / Dimensions and fixing system

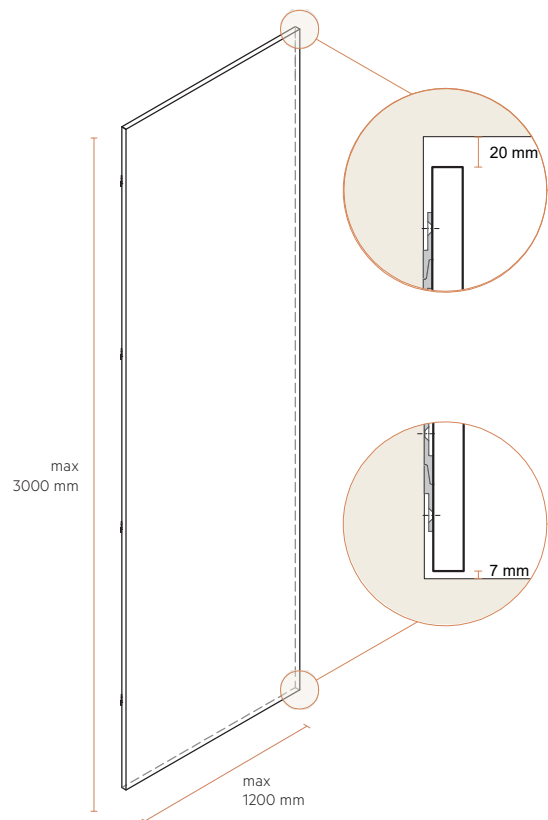

Aria superiore minima: 20 mm
Aria inferiore minima: 7 mm
Possibilità di prevedere uno scuretto superiore e inferiore

Minimum upper shadow: 20 mm
Minimum lower shadow: 7 mm
Possibility to provide upper and lower profile

Soluzioni d'angolo / Corner solutions

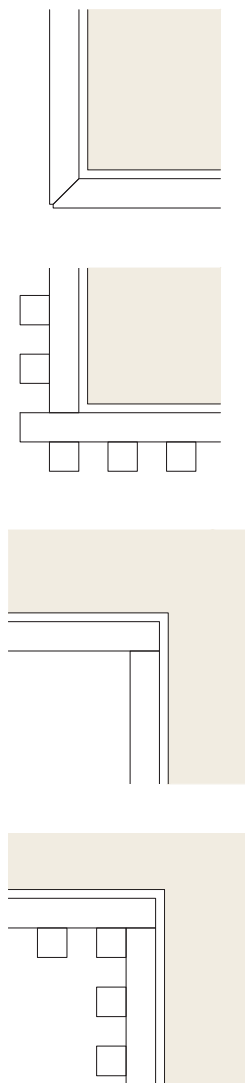

Illuminazione integrata / Integrated light

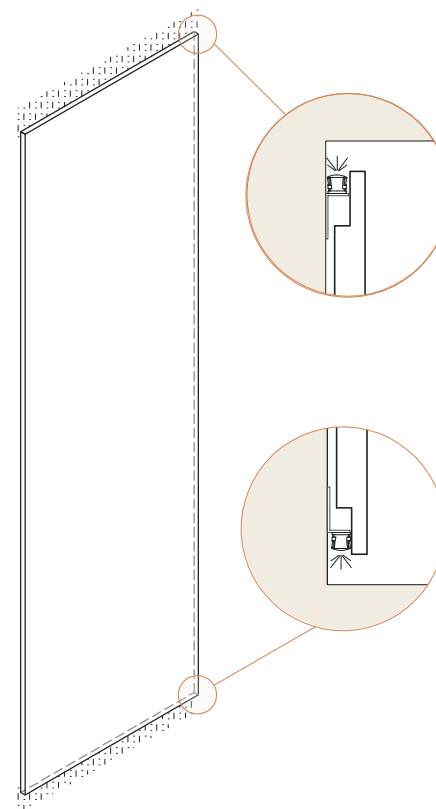

Sistema di Illuminazione superiore e inferiore, 2700°, 3000° o 4000° Kelvin
Upper and lower LED lighting system, 2700°, 3000° or 4000° Kelvin

Terminali di chiusura / Closing terminal



Terminale con scuretto nero
Terminal with black profile

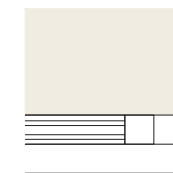

Terminale con gola in finitura
Terminal with groove in finish



Terminale in folding
Terminal with folding

Boiserie: caratteristiche tecniche

Boiserie: technical features

Dettagli / Details

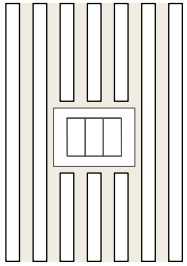

Alloggiamento interruttori e altri dispositivi
Holes for sockets and other devices

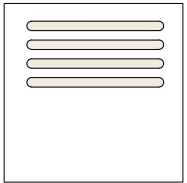

Fresate per sistema di ventilazione
Milled for ventilation system

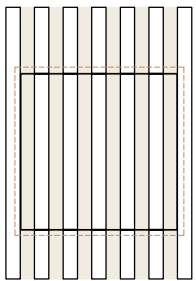

Vano tecnico a scomparsa
Hidden inspection door

Dettagli / Details

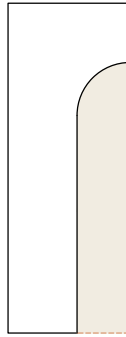

Taglio a misura e sagomatura pannelli
Customized panel shapes



Case TV TV Case

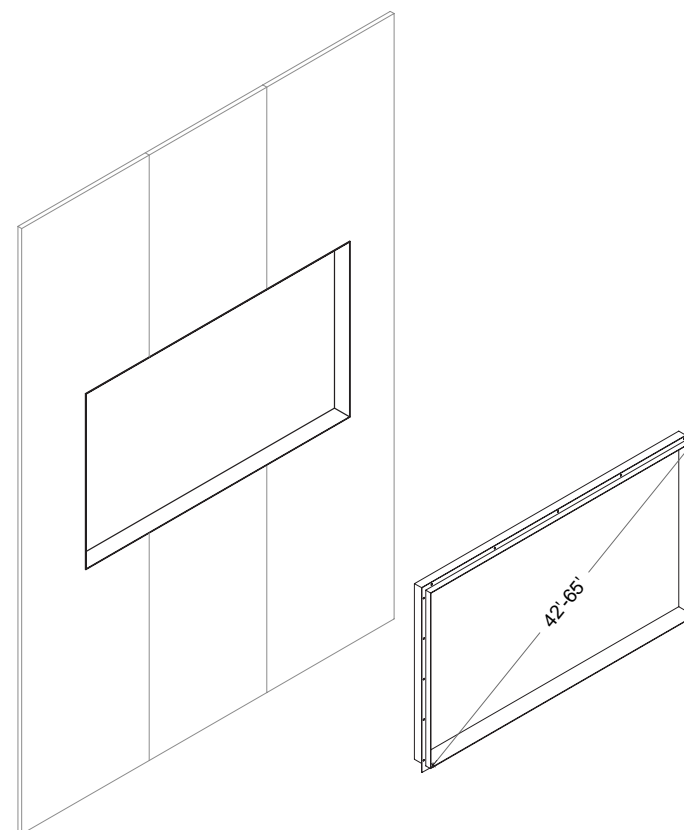

IT Il case in metallo verniciato definisce uno spazio per la TV permettendone la sua perfetta integrazione e coplanarità.

Nella versione standard è disponibile per TV da 42" a 65", in finitura opaca o metallizzata.

EN The painted metal case defines a space for the TV allowing its perfect integration and coplanarity with the boiserie.

In the standard version it is available for TVs from 52" to 65", in matt or metallic finish.

Mensola Shelf

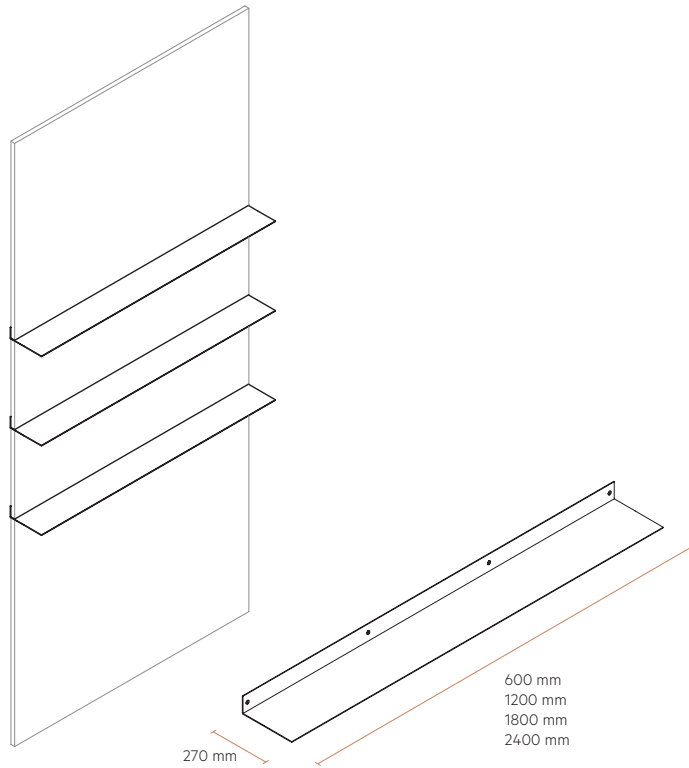

IT Le mensole in metallo verniciato, con sistema di aggancio completamente a scomparsa offrono un piano orizzontale profondo 270 mm.

Sono disponibili in quattro lunghezze 600 mm; 1200 mm; 1800 mm; 2400 mm.

EN The painted metal shelves, with a completely hidden fixing system, offer a 270 mm deep horizontal surface.

They are available in four lengths 600 mm; 1200 mm; 1800 mm; 2400 mm.



Porte integrate Integrated doors

IT Porte a battente o a bilico di spessore 60 mm, complete di serratura magnetica e cerniere a scomparsa. Le porte possono essere a tutta altezza o con sopra-luce; con montanti a vista o integrati; con o senza rivestimento dell'imbotte.

EN Hinged or pivot doors 60 mm thick, complete with magnetic lock and concealed hinges. The doors can be full height or with a transom, with visible or integrated frame.





Wall System: porte integrate / integrated doors
Finitura / Finishing: Skin, Smoked Eucalyptus



Porta a battente a tutta altezza Full height hinged door

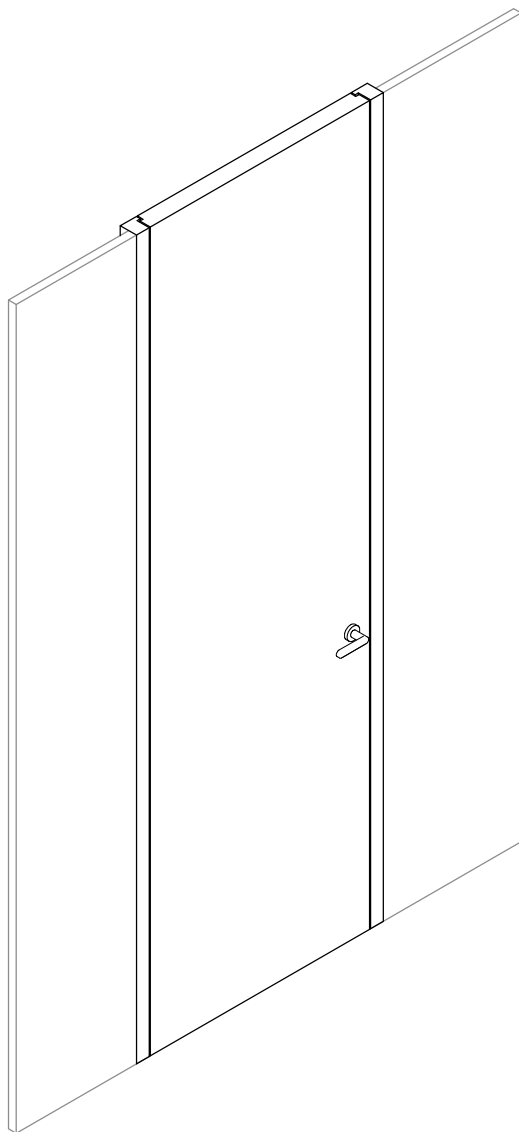

IT Porta a battente a tutta altezza complanare alla boiserie, con possibilità di apertura a spingere o a tirare sia a destra che a sinistra. Realizzata in tamburato sp. 60 mm.

EN Full-height flush to the boiserie hinged door, with the possibility of pushing or pulling opening both to the right and to the left. Made with honeycomb structure with 60 mm thickness.

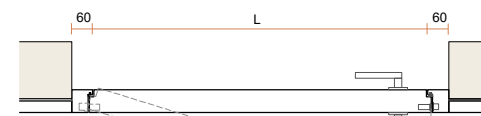

Porta a tirare
Door by pulling

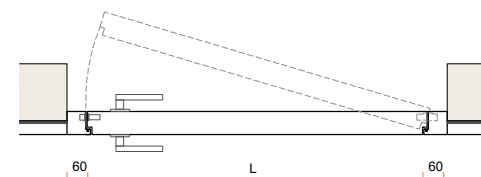

Porta a spingere
Door by pushing

Specifiche tecniche

Dimensioni	H max. 3000 mm; L max. 900 mm
Spessore	60 mm; 80 mm (porta Stike)
Apertura	A spingere; a tirare
Luce	Luce netta (L) = Foro porta - 120 mm
Serratura	Magnetica c/s nottolino o chiave
Maniglia	Link by Olivari (di serie)

Technical specifications

Dimensions	H max. 3000 mm; L max. 900 mm
Thickness	60 mm; 80 mm (porta Stike)
Opening	By pushing; by pulling
Net passage	Door holes - 120 mm
Lockset	Magnetic with or without latch or key
Handle	Link by Olivari (standard)

Porta a battente con sopra luce Hinged door with transom

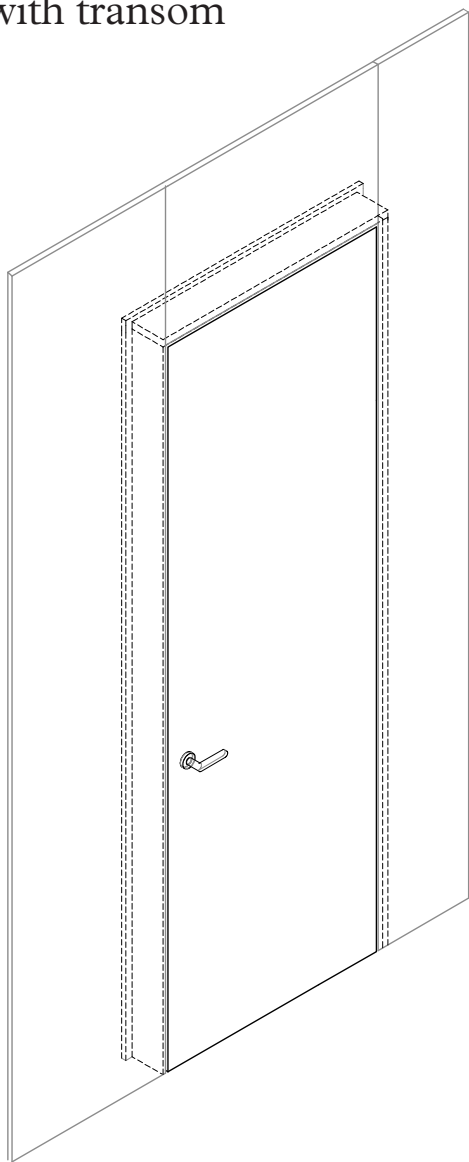

IT Porta a battente complanare alla boiserie, con battuta superiore e sopra luce. Possibilità di apertura a spingere o a tirare sia a destra che a sinistra.

Realizzata in tamburato sp. 60 mm. I montanti di battuta sono integrati nella boiserie. È possibile prevedere il rivestimento dell'imbotte in legno.

EN Full-height flush to the boiserie hinged door, with the possibility of pushing or pulling opening both to the right and to the left.

Made with honeycomb structure with 60 mm thickness. The door frame is integrated in the boiserie. Possibility to cover with the boiserie the door passage.

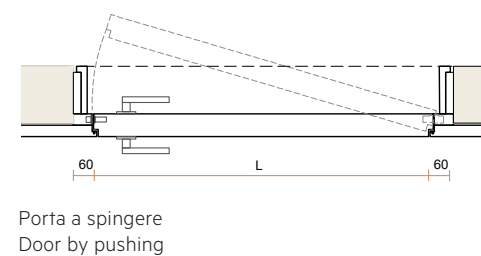
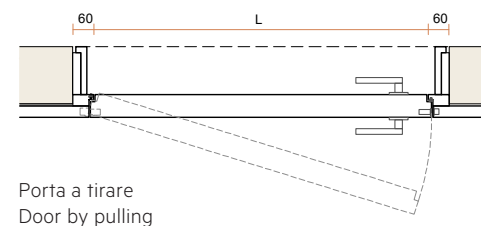

Specifiche tecniche

Dimensioni	H max. 2400 mm; L max. 900 mm
Spessore	60 mm; 80 mm (porta Stike)
Apertura	A spingere; a tirare
Luce	Luce netta (L) = Foro porta - 120 mm
Serratura	Magnetica c/s nottolino o chiave
Maniglia	Link by Olivari (di serie)

Technical specifications

Dimensions	H max. 2400 mm; L max. 900 mm
Thickness	60 mm; 80 mm (Stike door)
Opening	By pushing; by pulling
Net passage	Door holes - 120 mm
Lockset	Magnetic with or without latch or key
Handle	Link by Olivari (standard)

Porta Pivot

Pivot door

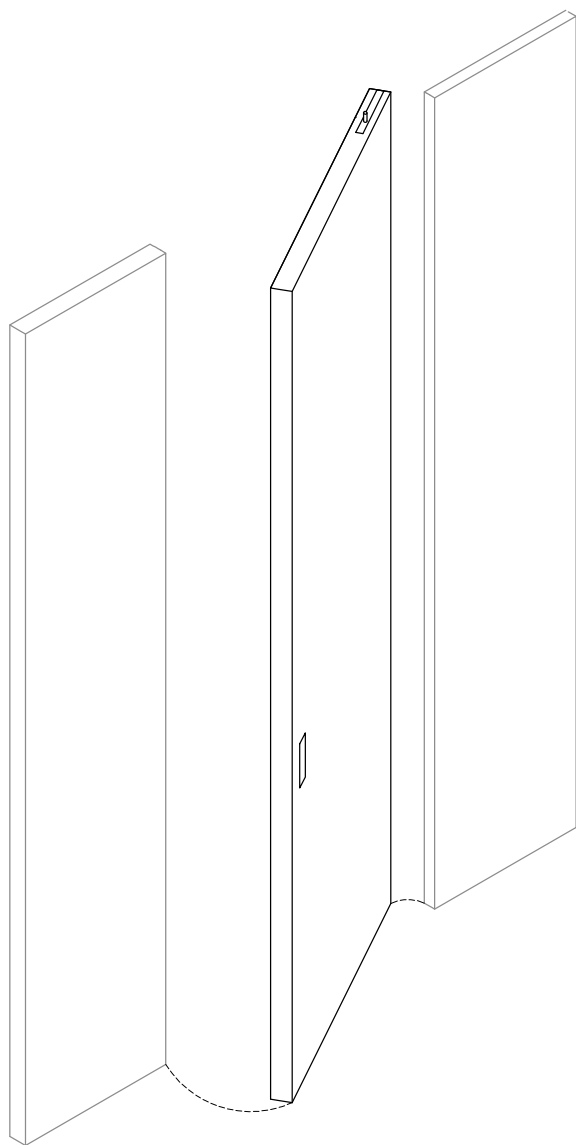

IT Porta pivottante a tutta altezza con fissaggio a soffitto e a pavimento. Permette di realizzare chiusure di dimensioni fino a 1200 mm con apertura da ambo i lati o da un lato soltanto.

EN Full-height pivoting door with ceiling and floor fixing. It allows you to create closures of sizes up to 1200 mm with opening on both sides or on one side only.

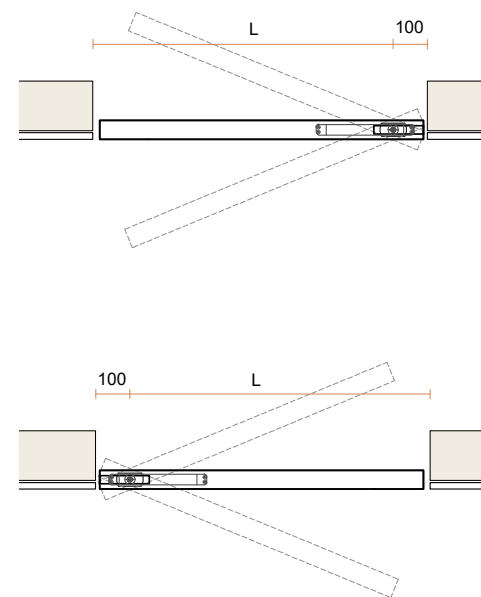

Specifiche tecniche

Dimensioni	H max. 3000 mm; L max. 1200 mm
Spessore	60 mm; 80 mm (porta Stike)
Apertura	A 180°; 90° a spingere; 90° a tirare
Luce	Luce netta (L) = Foro porta - 100 mm
Serratura	Magnetica c/s nottolino o chiave
Maniglia	Link by Olivari (di serie)

Technical specifications

Dimensions	H max. 3000 mm; L max. 1200 mm
Thickness	60 mm; 80 mm (Stike door)
Opening	180°, 90° pull or push
Net passage	Door holes - 100 mm
Lockset	Magnetic with or without latch or key
Handle	Link by Olivari (standard)

Porta integrata con armadiature Wardrobe pass-through hinged door

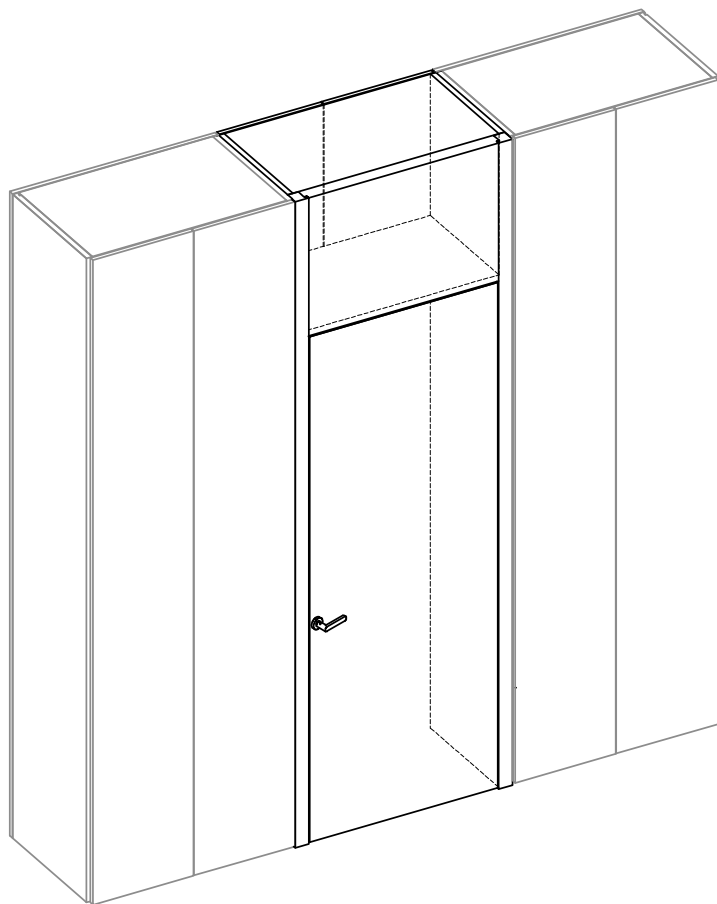

IT Porta a battente complanare alle armadiature, con vano contenitore superiore. Possibilità di apertura a spingere sia a destra che a sinistra. Realizzata in tamburato sp. 60 mm. Imbotte rivestito in essenza.

Per passaggi più ampi è possibile realizzare una porta a doppia anta.

EN Wardrobe pass-through hinged door, with upper bridge compartment. Possibility of opening by pushing both right and left. Made with 60 mm honeycomb structure. Internal passage covered in wood.

For larger passages it is possible to create a double door.

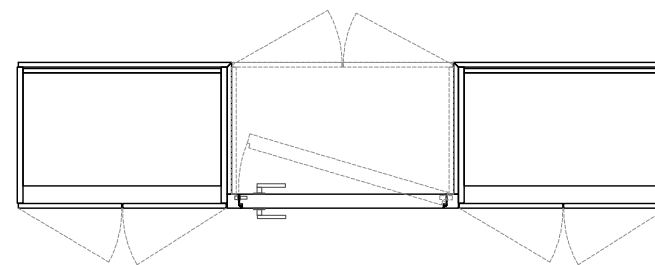

Specifiche tecniche

Dimensioni	H max. 3000 mm; L max. 900 mm
Spessore	60 mm; 80 mm (porta Stike)
Apertura	A spingere dx/sx
Luce	Luce netta (L) = Foro porta - 120 mm
Serratura	Magnetica c/s nottolino o chiave
Maniglia	Link by Olivari (di serie)

Technical specifications

Dimensions	H max. 3000 mm; L max. 900 mm
Thickness	60 mm; 80 mm (Stike door)
Opening	By pushing right/left
Net passage	Door holes - 120 mm
Lockset	Magnetic with or without latch or key
Handle	Link by Olivari (standard)

Armadiature Wardrobes

IT Integrati dietro la boiserie, gli armadi su misura offrono infinite possibilità di organizzazione dello spazio. Le ante prevedono apertura push-pull o con maniglia.

EN Integrated behind the boiserie, the custom-made wardrobes offer infinite possibilities for organizing the space. The doors could have push-pull or handle opening options.



Armadiature: moduli e dimensioni

Wardrobes: units and dimensions

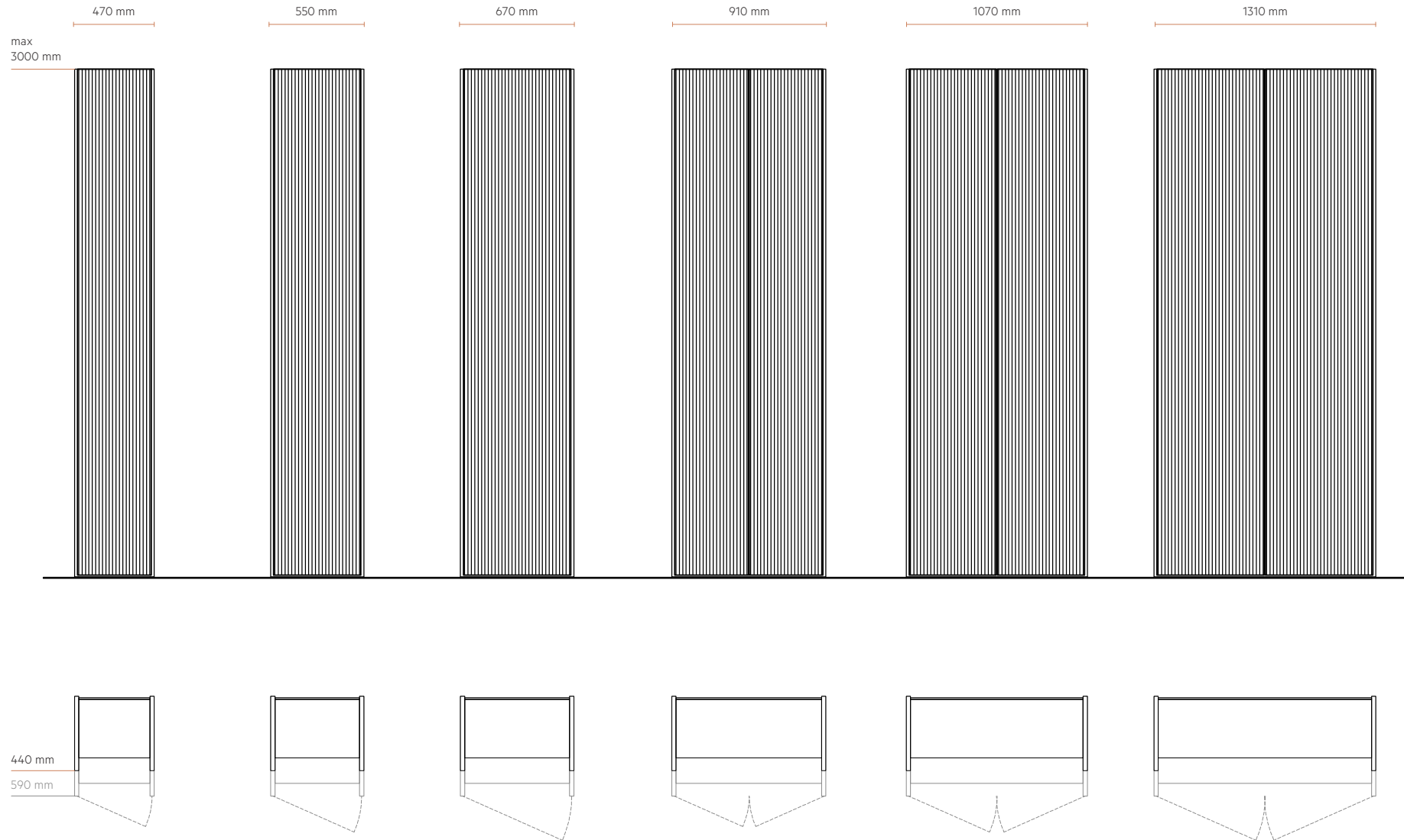

Per esigenze specifiche, le scocche armadio possono essere realizzate su misura. / For specific needs, wardrobes can be custom-made.

Day system

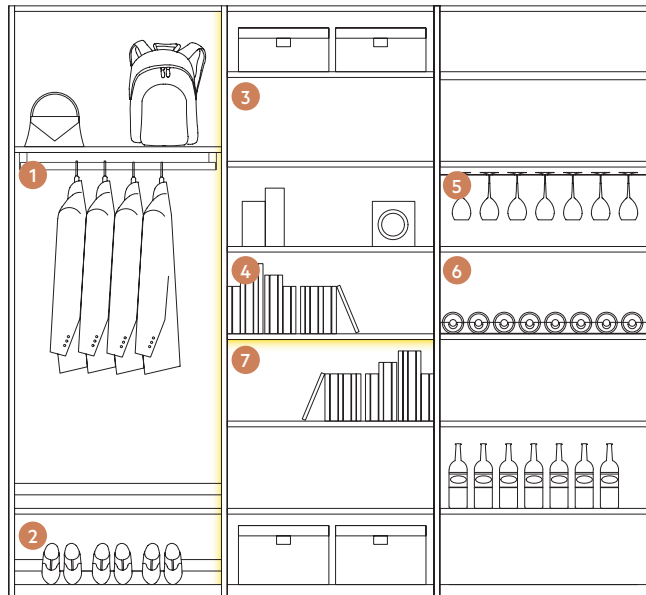

Accessori opzionali

- 01 Barra appenderia
- 02 Scarpiera
- 03 Ripiani
- 04 Fermalibri
- 05 Porta bicchieri
- 06 Porta bottiglie
- 07 Illuminazione strip led 3000k con accensione automatizzata

Optional accessories

- 01 Hanging rail
- 02 Shoes storage
- 03 Shelves
- 04 Book holder
- 05 Glass holder
- 06 Bottle holder
- 07 Automatic led light 3000k



Night system

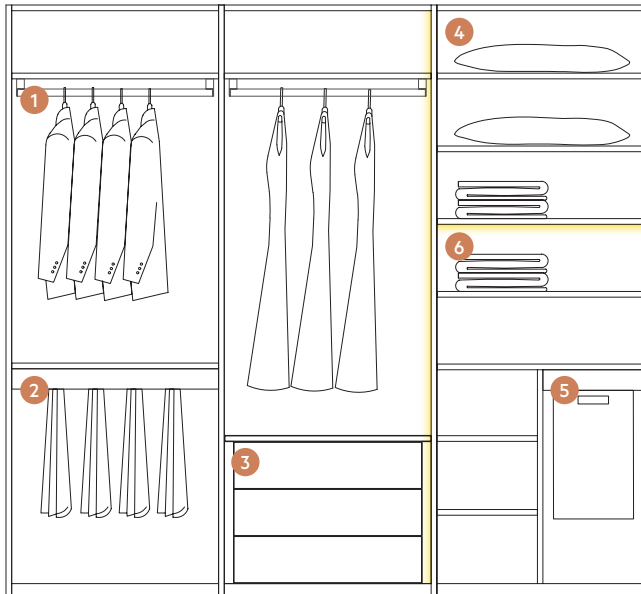

Accessori opzionali

- 01 Barra appenderia
- 02 Barra portapantaloni
- 03 Cassettiera
- 04 Ripiani
- 05 Cesto biancheria
- 06 Illuminazione strip led 3000k con accensione automatizzata

Optional accessories

- 01 Hanging rail
- 02 Trousers hanger
- 03 Drawers
- 04 Shelves
- 05 Hamper
- 06 Automatic led light 3000k



Altri accessori Other accessories

Illuminazione interna con accensione automatica / Automatic internal light

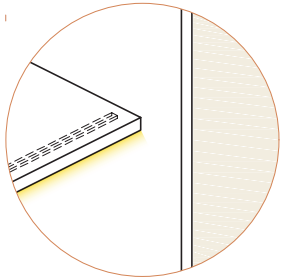

Profilo di alluminio con strip led 3000k su ripiano / Led lamps for shelf 3000k

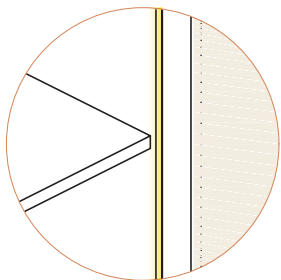

Profilo di alluminio con strip led 3000k su fianco / Led lamps for side 3000k

Ripiani / Shelves

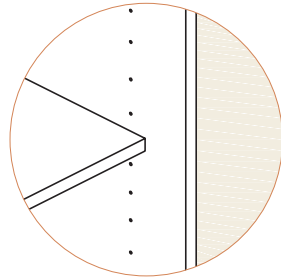

Ripiani fissi o movibili / Fixed or removable shelves

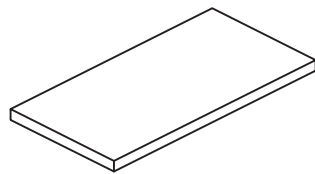

Ripiani in nobilitato sp. 30 mm / Melamine 30 mm shelves

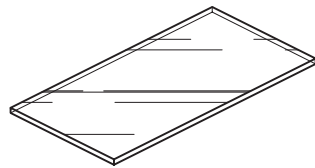

Ripiani in vetro / Glass shelves

Specchi interni / Internal mirrors

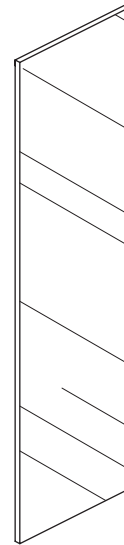

Rettangolare / Rectangular

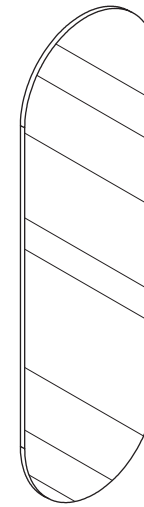

Ovale / Oval

Armadio bifacciale / doppio armadio Double sided wardrobe

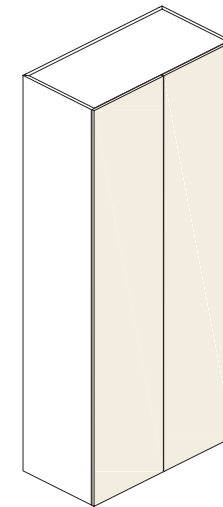

Lato A / Side A

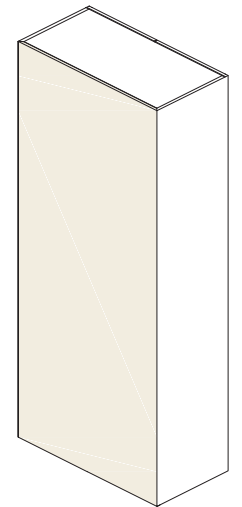

Lato B / Side B

Possibilità di realizzare armadi bifacciali, con schiena a vista o doppi armadi con apertura sia sul lato A che lato B.

Possibility of creating double-sided wardrobes, with finished back or double wardrobes with opening on both side A and side B.

Altri accessori Other accessories

Maniglie / Handles

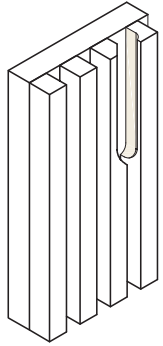

Presa maniglia fresata su
anta Strike / Milled handle
on Strike door

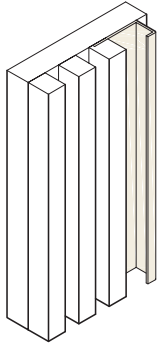

Profilo metallico su anta
Strike / Vertical metal profile
on Strike door

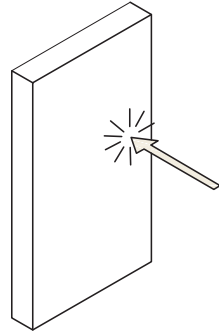

Push-Pull

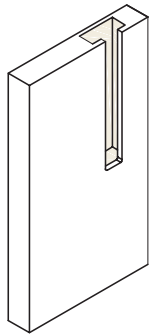

Presa maniglia fresata su
anta Skin / Milled handle on
Skin door

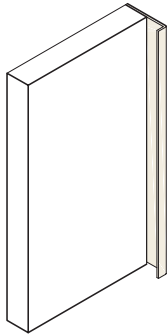

Profilo metallico su anta Skin
/ Vertical metal profile on
Skin door

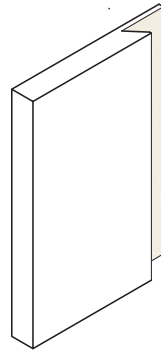

Gola verticale su anta Skin
/ Vertical groove handle
on Skin door



Ceiling System

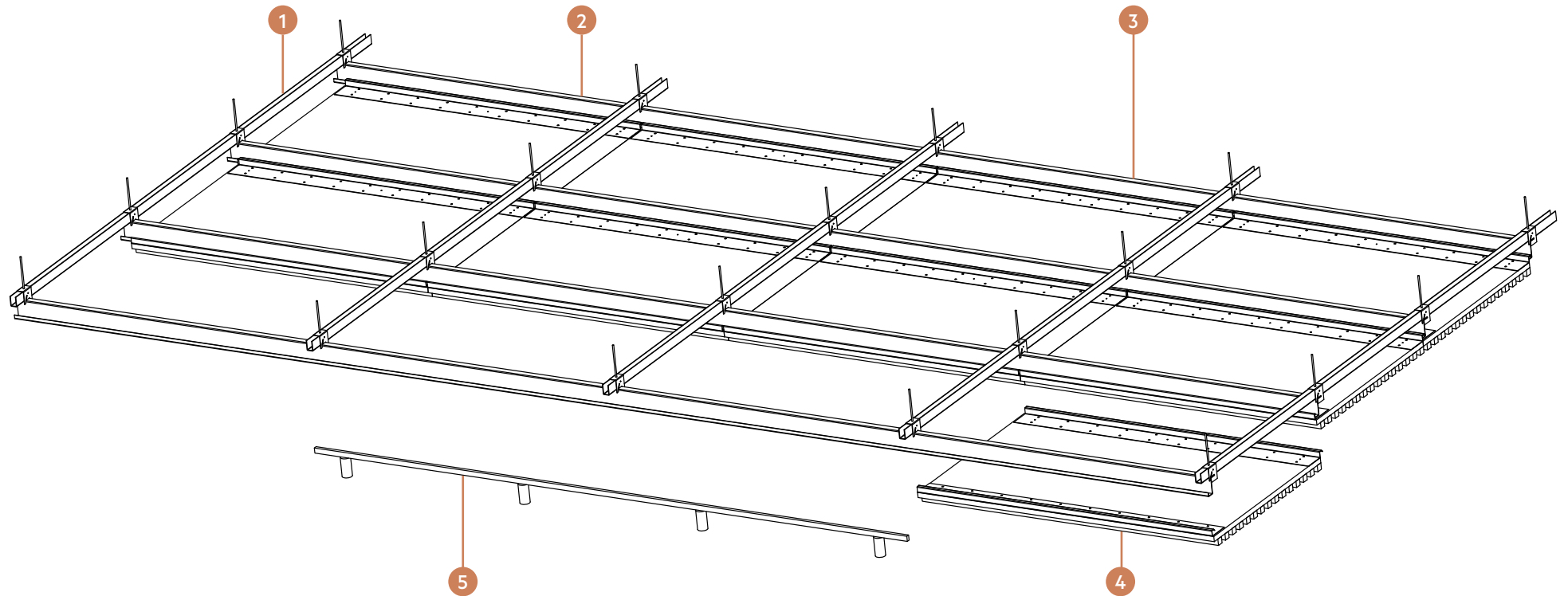

- 01 Orditura primaria
- 02 Orditura secondaria
- 03 Pendenza
- 04 Pannello di finitura smontabile
- 05 Illuminazione integrata

- 01 Primary structure
- 02 Secondary structure
- 03 Brackets
- 04 Ceiling panel
- 05 Integrated lights



Un abito in tre dimensioni A three-dimensional garment

IT Come un sarto che cuce capi su misura, Xilia veste il tuo ambiente. Grazie al Ceiling System, possiamo completare la "scatola architettonica", creando ambienti di prestigio, caldi e accoglienti, senza rinunciare alla praticità di un controsoffitto tecnico e ispezionabile.

EN Like a tailor who sews made-to-measure garments, Xilia dresses your environment. Thanks to the Ceiling System, we can complete the "architectural box", creating prestigious, warm and welcoming environments, compromising the practicality of a technical and inspectable wood ceiling.



Ceiling System: caratteristiche tecniche

Ceiling System: technical features

Dimensioni / Dimensions

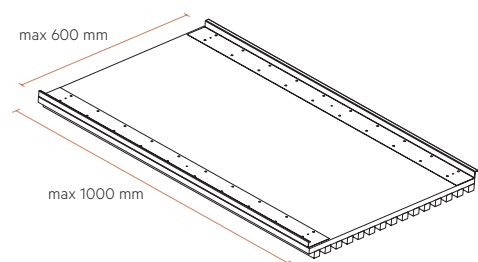

Dim. massime del pannello 600x1000 mm
Maximum dimensions: 600x1000 mm

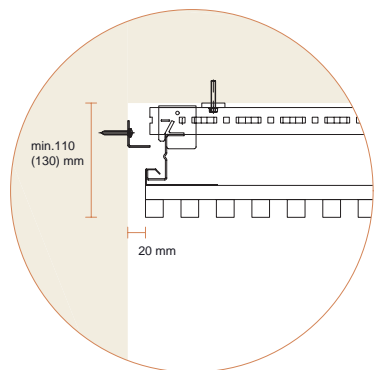

Ingombro minimo del sistema:
110 mm (130 mm con Strike)
Scuretto laterale: 20 mm

Minimum system size:
110 mm (130 mm with Strike)
Lateral aluminium shadow gap: 20 mm

Montaggio e Ispezione / Installation and inspection

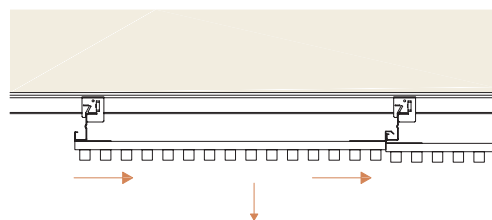
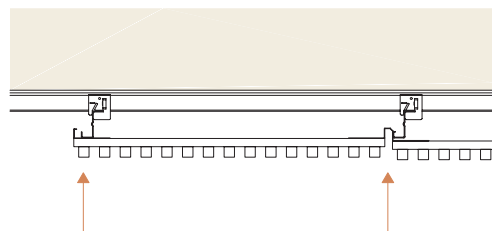
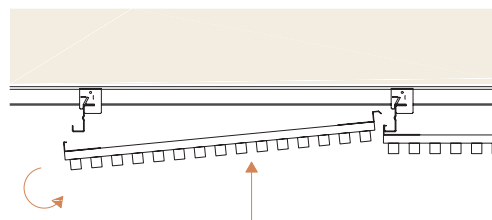

Illuminazioni integrata / Integrated lights

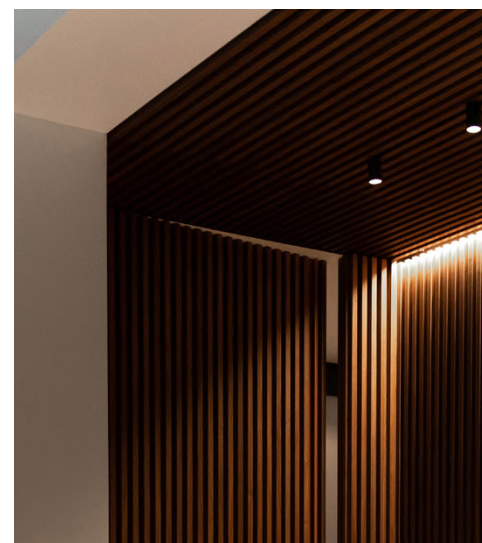
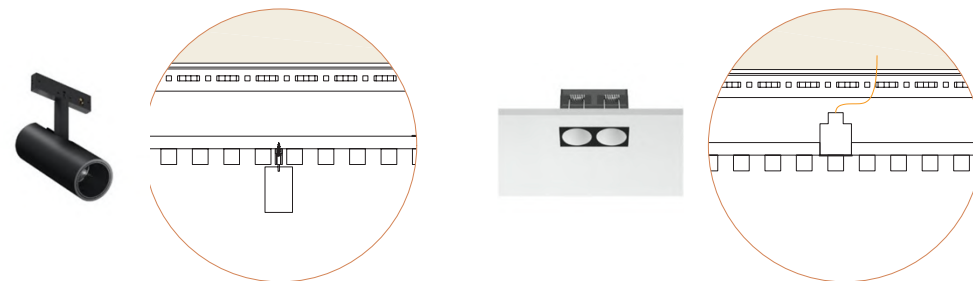

Integrabile con:

- Spotlight su binario magnetico
- Spotlight a incasso
- Striped

Possibility to integrate with any kind of light:

- Spotlight on tracks
- Recessed spotlight
- Striped

Finiture Finishes

Skin Natural

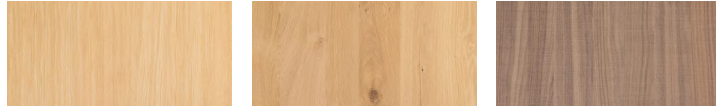

Fresh oak

Knotted oak

Canaletto



Ash

Elm

Skin Smoked

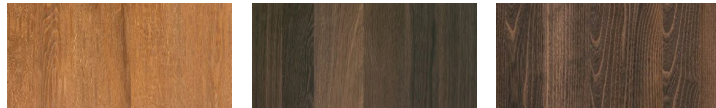

Golden oak

Smoked oak

Smoked acanthus



Smoked eucalyptus

Smoked quercus

Skin Stained

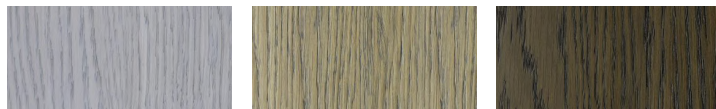

Iced oak

Nordic oak

Chocolate oak



Graphite oak

Carbon oak

Strike

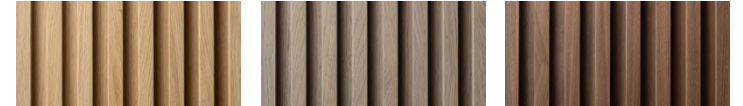

Fresh oak

Nordic oak

Canaletto

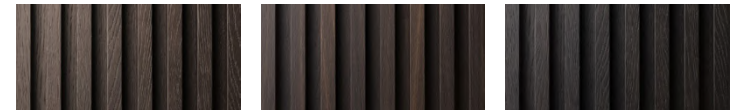

Graphite oak

Smoked oak

Carbon oak

Laccato opaco Matte lacquered



Laccato opaco su richiesta (RAL/NCS)

Matte lacquered available on request (RAL/NCS)

Nobilitato Laminated



Lino terra

Lino antracite

Grigio ancora



Grigio ciottolo

Grigio onice

CREDITS

Concept & Engineering: Xilia R&D
Graphics: Studio Nuvole

Photography:
Xilia
Francesco Caredda
Luigi Filetici
Marco Zanta

Copyright © 2024 Xilia Wood Experience.
Tutti i diritti riservati. Nessuna parte di questo catalogo può essere riprodotta in qualsiasi forma mediante stampa, fotocopia, microfilm, registrazione o altri mezzi senza previa autorizzazione scritta degli editori. L'azienda ha il diritto di modificare i propri prodotti al fine di migliorarne la qualità in qualsiasi momento senza preavviso.

Copyright © 2024 Xilia Wood Experience.
All rights reserved. No part of this catalogue may be reproduced in any form by print, photocopy, microfilm, recording or other means without the prior written permission of the publishers. The company is entitled to modify its products to the aim of improving their quality at any time without giving prior notice.

HEADQUARTER & SHOWROOM

Via Callalta Capoluogo, 12
31045 Motta di Livenza (TV) - Italy

info@xiliawood.com
+39 0422 1626003

XILIAWOOD.COM

