

XILIA

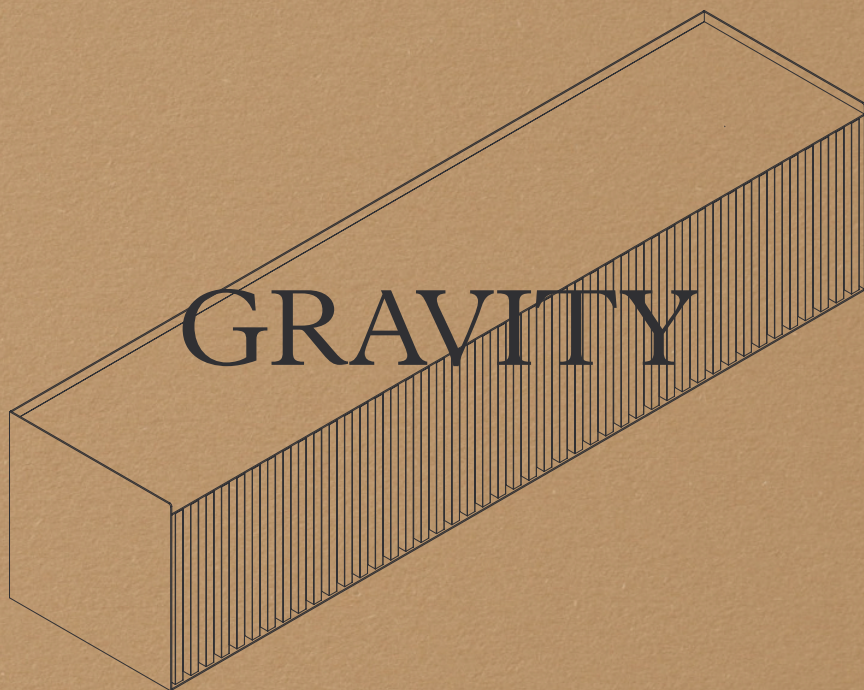

SUSPENDED SIDEBOARD



X I L I A

SUSPENDED SIDBOARD
DESIGN: MARTINELLI VENEZIA

Sospesa tra design e funzionalità Suspended between design and functionality

IT Gravity, la madia a sospensione di Xilia disegnata dallo Studio Martinelli Venezia, è un complemento d'arredo senza fronzoli: una fusione perfetta di tecnica e funzionalità, che la fa sembrare magicamente sospesa alla parete senza compromettere l'estetica.

Il suo design gioca con i contrasti tra legno e metallo, spessori differenti, leggerezza estetica e robustezza funzionale, rivelando le proprietà dei materiali e le loro infinite possibilità di combinazione.

EN Gravity, Xilia's suspended sideboard designed by Studio Martinelli Venezia, is a no-frills furnishing complement: a perfect fusion of technique and functionality, making it appear magically suspended on the wall without compromising aesthetics.

Its design plays with contrasts between wood and metal, varying thicknesses, aesthetic lightness, and functional robustness, revealing the intrinsic properties of the materials and their endless combination possibilities.





Gravity L 2400 mm, frontali in Canaletto Strike, cover metallica in Beige red. **Outstanding** L 2400 mm mensole retroilluminate in Beige red. Ambiente: residenziale, living

Gravity L 2400 mm, door panels in Strike Canaletto, metallic cover in Beige red. **Outstanding** L 2400 mm backlit shelves in Beige red. Environment: residential, living

Personalizzazione massima, design sorprendente Maximum customization, stunning design

IT Gravity è stata progettata per offrire il massimo in termini di personalizzazione. Grazie ai suoi moduli componibili, si adatta facilmente a qualsiasi esigenza, offrendo spazio in ogni contesto.

La funzionalità è garantita dalle molteplici configurazioni disponibili: dall'apertura alla retroilluminazione, senza tralasciare l'accessoristica interna. Con Gravity, l'organizzazione diventa un gioco da ragazzi!

EN Gravity has been designed to offer maximum customization. Thanks to its modular components, it easily adapts to any need, providing space in any setting.

Functionality is ensured by the numerous available configurations: from the opening options to backlighting, without neglecting internal accessories. With Gravity, organization becomes a breeze!

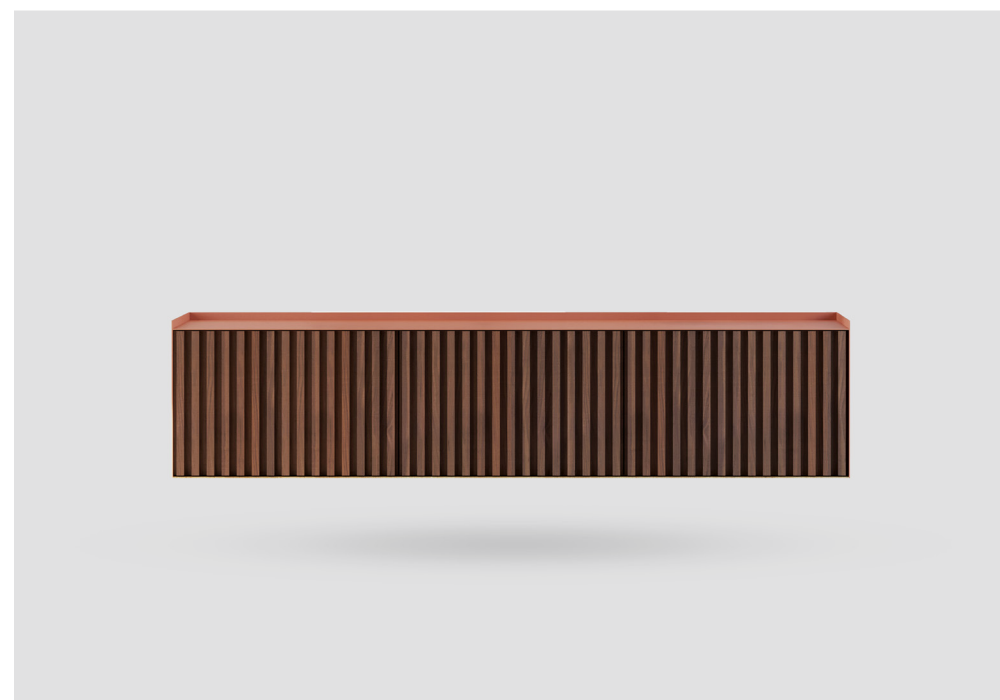



Gravity L 1800 mm, frontali in Skin Fresh Oak, cover metallica in Pale green. Ambiente: residenziale, living

Gravity L 1800 mm, door panels in Skin Fresh Oak, metallic cover in Pale green. Environment: residential, living

La rivoluzione sta in tutto ciò che non si vede The revolution lies in everything that is not seen

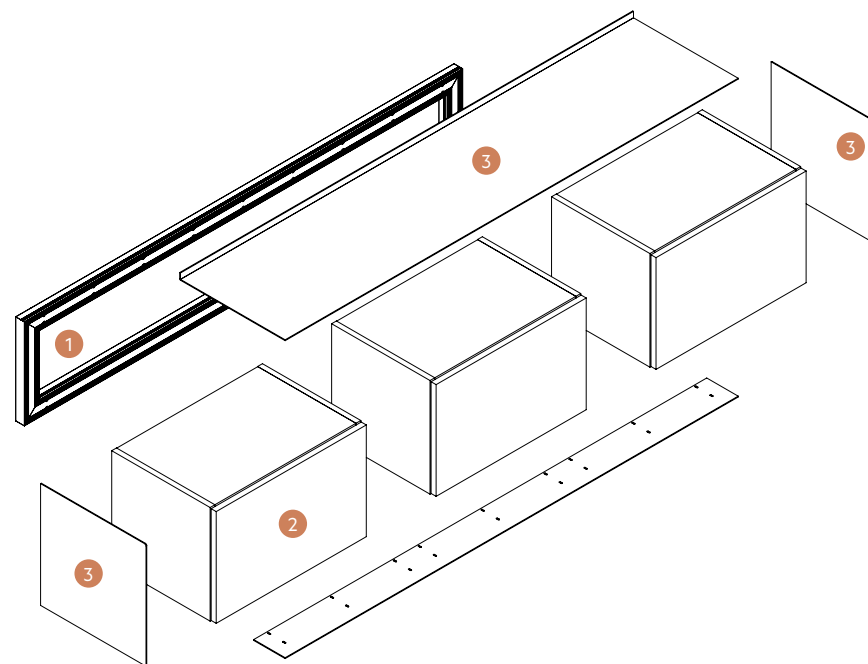

IT Gravity è stata concepita per rendere l'installazione semplice, veloce e intuitiva. Il suo sistema di fissaggio, realizzato con estrusi di alluminio proprietari, permette di gestire le imperfezioni delle pareti.

Gravity è un complemento che guarda al futuro: la madia infatti può essere disassemblata in qualsiasi momento e riutilizzata senza limiti. Anche questo per noi è design.

EN Gravity has been designed to make installation simple, fast, and intuitive. Its fixing system, made with proprietary aluminum extrusions, allows for managing wall imperfections.

Gravity is a complement that looks to the future: the sideboard can indeed be disassembled at any time and reused endlessly. For us, this too is design.

01 Il telaio di fissaggio a muro, progettato con due cave per consentire l'alloggio della striscia superiore ed inferiore e realizzato con estrusi in alluminio proprietari, garantisce una rapida installazione oltre alla possibilità di compensare eventuali imperfezioni della parete grazie ai suoi livellatori a scomparsa. / The wall mounting frame, designed with two slots

to accommodate the upper and lower strip LEDs and made from proprietary aluminium extrusions, ensures quick installation as well as the ability to compensate for any wall imperfections thanks to its built-in levelers.

02 Scocche fornite già assemblate, provviste di ulteriori regolatori a scomparsa, consentono il montaggio da

parte di una sola persona. / Shells provided already assembled, equipped with additional hidden adjusters, allow assembly by a single person.

03 Cover metallica verniciata a polveri, con la possibilità di scelta tra colori più classici e tinte più audaci. / Powder-coated metal cover, available in a variety of classic colors and bold shades.



Gravity L 1800 mm, frontali in Skin Fresh Oak, cover metallica in Pale green. Ambiente: residenziale, living

Gravity L 1800 mm, door panels in Skin Fresh Oak, metallic cover in Pale green. Environment: residential, living



Caratteristiche tecniche

Technical features

Dimensioni e modularità / Dimensions and modularity

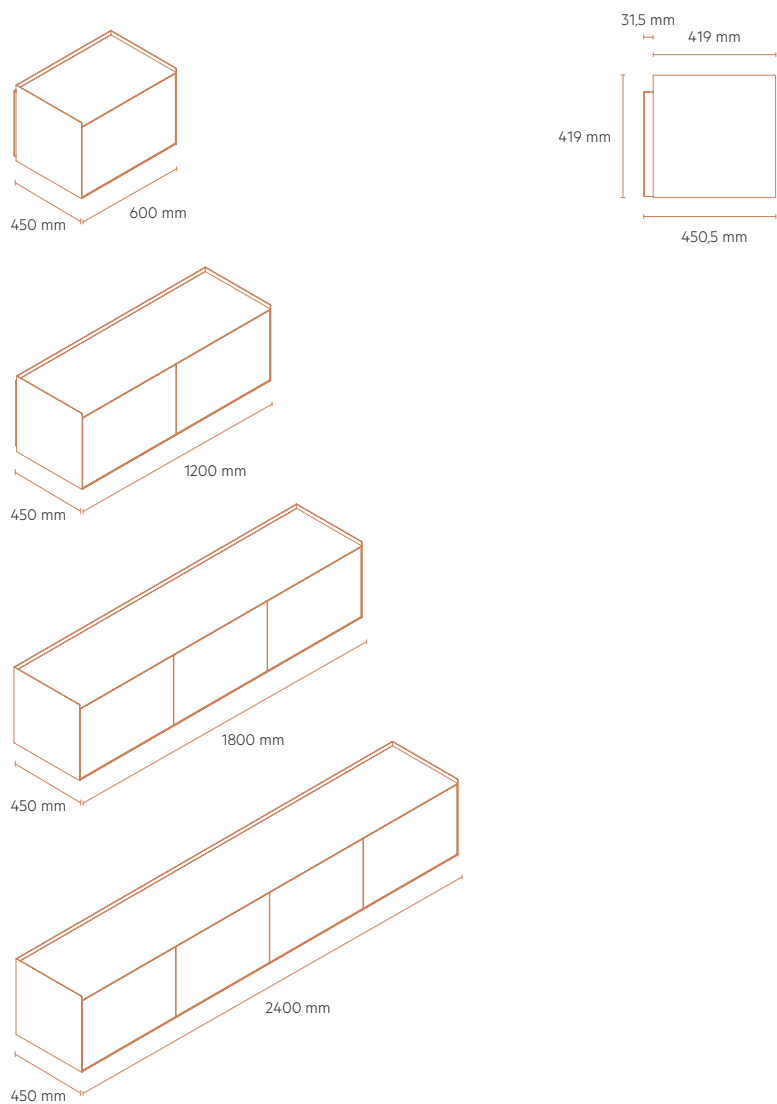

Tipologia di apertura: anta

Type of opening: door

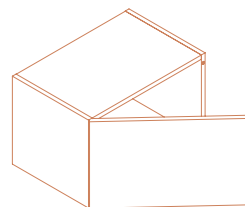

Tipologia di apertura: cassetto

Type of opening: drawer

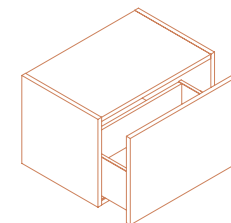

Accessori: ripiano in vetro

Optional: glass shelf

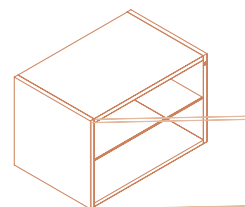

Accessori: cassetto interno

Optional: internal drawer

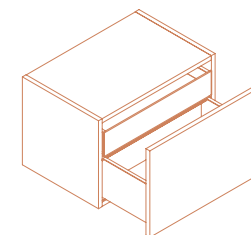

Accessori: passacavi

Optional: cable duct

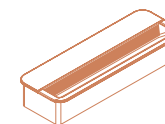

Illuminazione esterna / External lighting

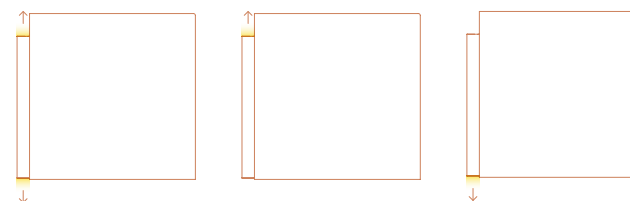

Illuminazione interna / Internal lighting

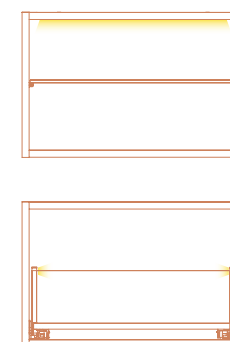

Finiture Finishes

Ante Skin / Skin doors



Fresh oak



Canaletto



Carbon oak



Velasca

Ante Strike / Strike doors



Fresh oak



Canaletto

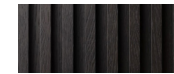

Carbon oak



Velasca

Scocche in nobilitato / Laminated shells



Light grey



Summerrain grey



Basalt grey



Terracotta red



Dove blue



Pistacchio green

Rivestimento esterno in metallo verniciato / Lacquered metal external covering



Jet black

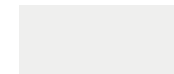

Traffic white



Olive drab



Champagne



Traffic grey B



Telegrey 4



Pure orange



Beige red



Copper



Ultramarine blue



Distant blue



Pastel blue



Signal green



Raseda green



Pale green

Rivestimento esterno in metallo verniciato trasparente / Transparent lacquered metal external covering



Natural



Xilia, wood spaces with an emotional touch

IT Xilia è specializzata nella progettazione e produzione di sistemi di dressing dello spazio composti da rivestimenti a parete e soffitto, porte e armadiature integrate. A questi si uniscono complementi dalla spiccata personalità, in cui il denominatore comune è rappresentato dall'esperienza tattile della superficie.

Le soluzioni Xilia migliorano la percezione degli spazi, trasformando le idee creative in prodotti intelligenti, funzionali e sostenibili dal grande appeal estetico. Un mondo di sensazioni nel palmo della mano.

EN Xilia is specialized in the design and production of dressing systems made of wall and ceiling coverings, doors and integrated wardrobes. These are complemented by distinctive accessories, in which the common denominator is represented by the tactile experience of the wooden surface.

Xilia solutions improve the perception of spaces, transforming creative ideas into intelligent, functional and sustainable products with great aesthetic appeal. A world of sensations in the palm of your hand.

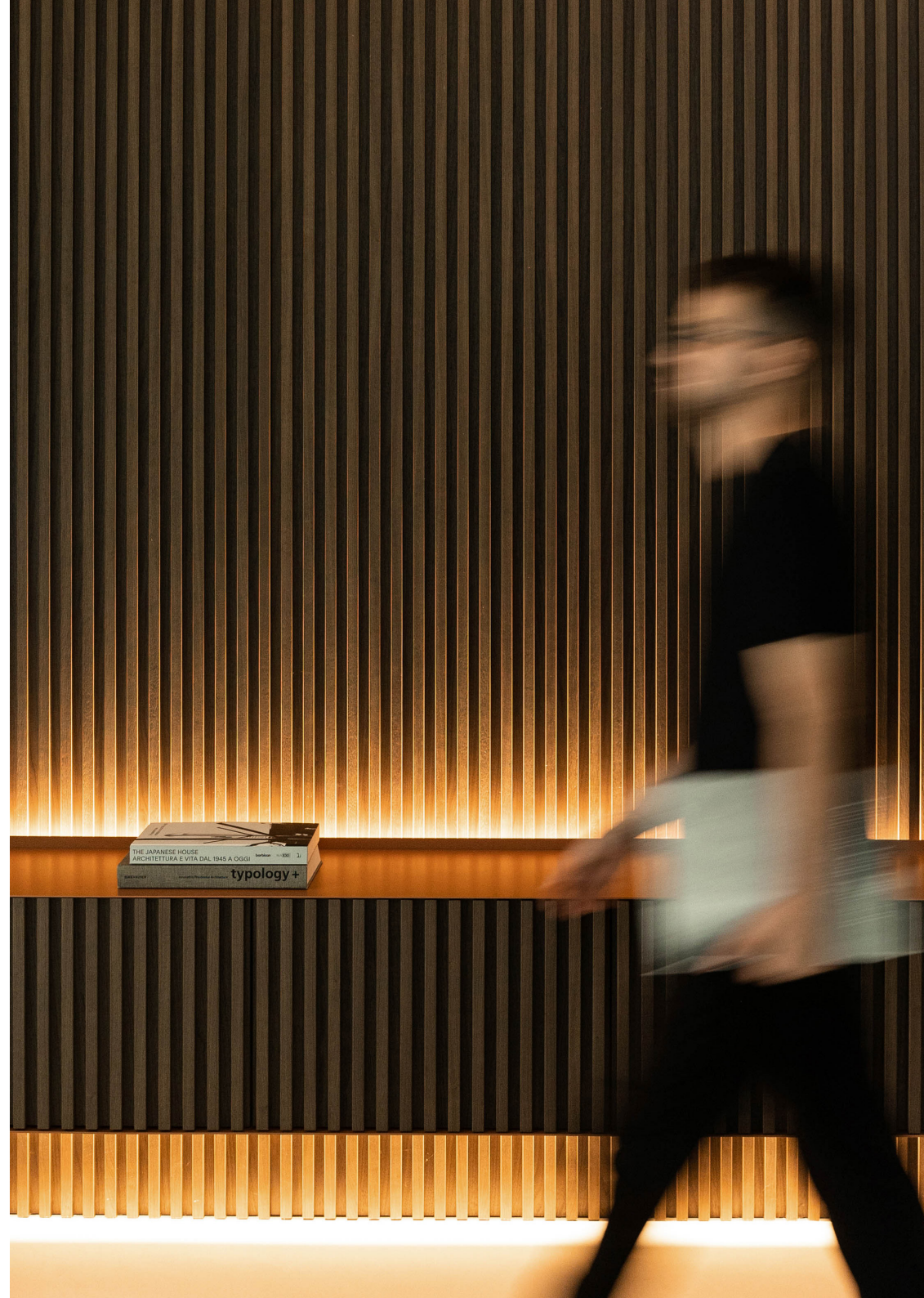

CREDITS

Concept: Martinelli Venezia
Engineering: Iaco Design Studio
Render: Orygine
Art Direction & Graphics: Studio Nuvole

Thanks to:
Bosa, Martinelli Luce, Carl Hansen & Søn,
Tacchini, Gufram

Copyright © 2024 Xilia Wood Experience.
Tutti i diritti riservati. Nessuna parte di questo catalogo
può essere riprodotta in qualsiasi forma mediante stampa,
fotocopia, microfilm, registrazione o altri mezzi senza previa
autorizzazione scritta degli editori. L'azienda ha il diritto di
modificare i propri prodotti al fine di migliorarne la qualità
in qualsiasi momento senza preavviso.

Copyright © 2024 Xilia Wood Experience.
All rights reserved. No part of this catalogue may be
reproduced in any form by print, photocopy, microfilm,
recording or other means without the prior written permission
of the publishers. The company is entitled to modify its
products to the aim of improving their quality at any time
without giving prior notice.

HEADQUARTER & SHOWROOM

Via Callalta Capoluogo, 12
31045 Motta di Livenza (TV) - Italy

info@xiliawood.com
+39 0422 1626003

XILIAWOOD.COM

